

Warning:

- 1-Ride-on car is designed for children up 12-36 months old. Ride's weight must not exceed 25kgs. as there is insufficient strength to support overweight.
- 2-Product is designed to seat 1 child at a time to avoid injuries.
- 3-Parental guidance and supervision are strongly advised to ensure safe riding.
- 4-Adult assembly and installation of all parts are required to ensure safety.
- 5-Batteries to be handled by adults.
- 6-Take care of riding and avoid going near streets,crossroads,all traffic areas,swimming pools,and stairs.
- 7-Without regular check of the product,it will cause overturn or fall
- 8-Check to see occasionally that the nut and bolt on the steering wheel is tight and secure.
- 9-Dangers may present if the product is not correctly assembled.
- 10-Shoes must be worn in use.

Battery Handling:

- 1-Battery must be handled by adults only.
- 2-Always remove exhausted batteries.
- 3-Use AA size batteries only.
- 4-Alkaline batteries are recommended.
- 5-Always remove batteries when the unit is not going to be used for an extended period of time.
- 6-When replacing new batteries,always replace all batteries.
- 7-Do not mix old and new batteries.
- 8-Do not mix Alkaline,Standard(Carbon-Zinc),or Rechargeable(Nickel-Cadmium)batteries.
- 9-Do not dispose of batteries in fire,batteries may explode or leak.
- 10-Non-rechargeable batteries are not to be recharged
- 11-Rechargeable batteries are to be removed from the toy before being charged
- 12-Rechargeable batteries are only to be charged under adult supervision
- 13-Batteries are to be inserted with the correct polarity
- 14-The supply terminals are not to be short-circuited

Bandits and Angels 

Item No.:HZ656/NPT8513
Activity Ride-On

Instructions Manual

WARNING
ADULT ASSEMBLY
REQUEST.



"Mercedes-Benz"  and the design of enclosed product are subject to intellectual property protection owned by Daimler AG.They are used by Ningbo Prince Toys Co.,Ltd. under license.
Manufacturer: Dutch Bandits B. V. , Jansstraat 69, 2011 RV HAARLEM
www. dutchbandits.com

INSTRUCTIONS

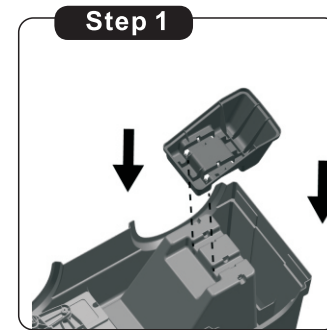

1.Place the anti-tumble shelf into the rear of the body.

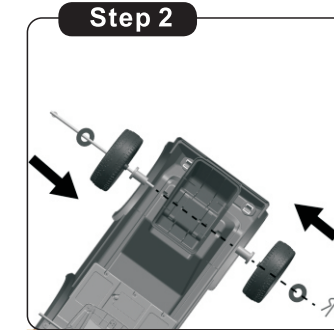

2.Insert the rear wheel axle through washer,wheel,plastic ring into the body,tighten using a cotter pin.

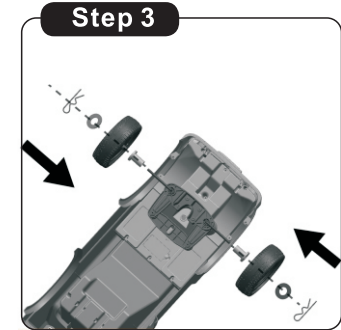

3.Assemble the two front wheels, insert the plastic ring,wheel and washer,tighten using a cotter pin.

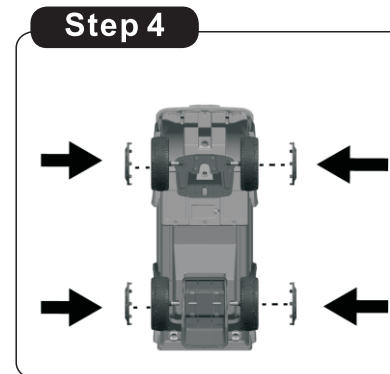

4.Place the four wheel caps into the four wheels.

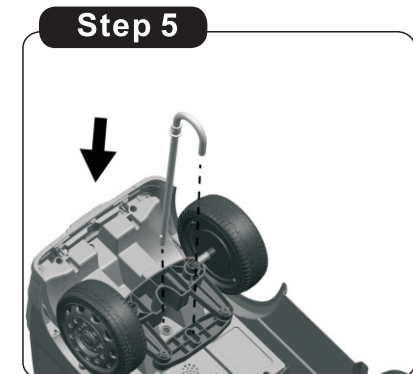

5.Install the J-shaped stick at the assigned location as picture.

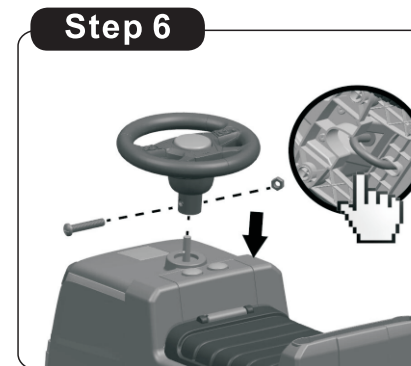

6.Loosen the bolt and nut in the steering wheel first,then place the J-shaped stick,insert the bolt and tighten the nut with a screwdriver.







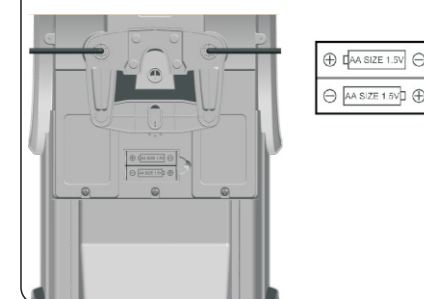





7.Insert the backrest over the hole in the rear of the body,be certain the backrest is completely seated.

BATTERY CHANGE



Turn over the car body, and find the battery house. Loosen the screws with a screwdriver. Put 2 AA batteries in the battery house, then tight the screw with a screwdriver.

COMPONENTS LIST

| | | |
|---|---|--|
| 1. Car Body 1PC  | 2. Steering wheel 1PC  | 3.Backrest 1PC  |
| 4.Wheel 4PCS  | 5.Wheel Cap 4PCS  | 6.Anti-tumble Shelf 1PC  |
| 7.J-shaped Stick 1PC  | 8.Rear Wheel Axle 1PC  | 9.Ring 4PCS  |
| 10. Washer 5PCS (1 replacement piece)  | 11. Cotter Pin 4PCS (1 replacement piece)  | |